

## VOLANS PREMIUM Product Code DT. Volans Premium 24v (add suffix see below)

IP54 zone 2 **CE** **LED** IEE : A+ EN 60598.

DESCRIPTION / Linear flexible LED strip, 10mm wide with invisible Dow Corning resin coated IP54

Dimensions (mm)  
4 (h) x 10 (width)

WHY USE THIS: Versatile (SMT) LED of high quality CRI90 and high performance. Very close pitch allows for 50mm cutting centres. Ideal for long runs. Fully dimmable and matched with many profiles suitable for all general lighting applications. Including wet areas.

Cut-out (mm)  
N/A

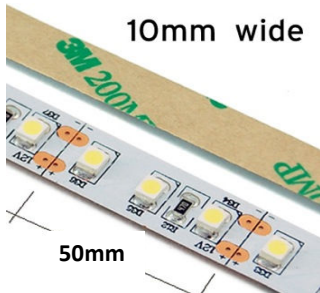

10MM PITCH, CUTTING CENTRES 50MM

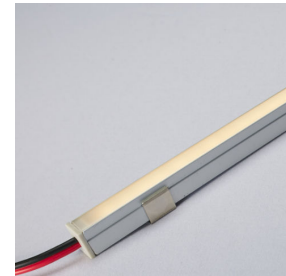

Contact us for the range of profiles

<b>material light fixture</b>	PVC / plastic mix; copper conductors 4oz
<b>colours &amp; finish/ (suffix)</b>	Clear
<b>light source &amp; voltage options</b> (PLEASE CONTACT US FOR ALTERNATIVE SOURCES)	a) (2835) 5w/m LED 140deg (400 lms/m) 24v DC b) (2835) 10w/m LED 140deg (800 lms/m) 24v DC c) (2835) 15w/m LED 140deg (1150 lms/m) 24v DC d)
<b>colour temperature /(suffix)</b>	120 LEDs/m
<b>CRI (colour render) /(suffix) MacAdam</b>	<b>2400K* / 2700K / 3000K / 4000K / 6000k* (*to order)</b> 90+ 3
<b>Controls options /(suffix)</b>	phase dimming DALI 0-10V
<b>Optional Accessories</b>	See p.2 for available profiles See p.3-4 for driver options
<b>AV. Weight (kg)</b>	0.04/m
<b>Emergency Available?</b>	Yes
<b>Special Notes</b>	<span style="color: red;">Supplied with 1m attached 'power-lead'. <u>Cutting and soldering service available. Supplied with 3m tape as standard</u></span>

### technical performance

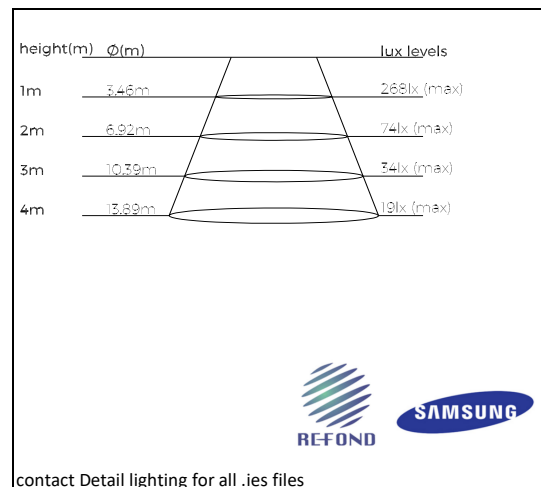

# PROFILES FOR VOLANS 10MM WIDE

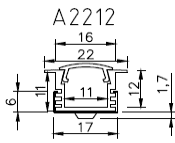

A2212  
For routing  
joinery

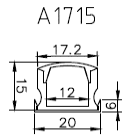

A1715  
General  
purpose - can  
be trimless

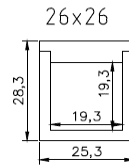

26x26  
Outdoor sealed

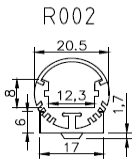

R002

16x18mm



Sealed wet  
areas

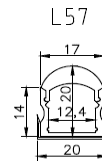

L57

Lensed for partial  
wall washing

Pivoting mount  
for A1715



Coffers & shadow gap

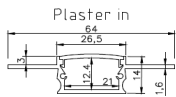

Plaster in

Trimless. Detail

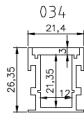

034

Outdoor  
walk over  
sealed.

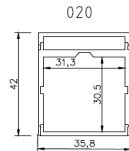

020

Any length  
Ceiling surface  
commercial  
(suspended  
available)

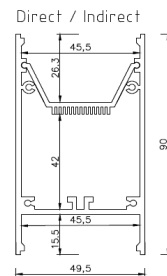

Direct / Indirect

Any length  
Suspended  
Commercial

Image	Code	dims	IP rating	Power	Inrush (A)	Comment
	<b>DT.HLG-480-24</b> 	262 X 125 X 43.8mm	IP65	480w	70A	For dimming use with MULTIPLE DT.ECP-701-8A below  (additional in-rush current limiter available)
	<b>DT.HLG-320</b> 	252 X 69 X 45MM	IP67	320w	70A	POTENTIOMETER BUILT-IN  For dimming use with MULTIPLE DT.ECP-701-8A below (additional in-rush current limiter available)
	<b>DT.HLG-240</b> 	247 X 69 X 39MM	IP67	240w	75A	POTENTIOMETER BUILT-IN  For dimming use with MULTIPLE DT.ECP-701-8A below  (additional in-rush current limiter available)
	<b>DT.SL-24200D024</b>	235 X 120 X 56MM	IP67	200w	75A	For dimming use with DT.ECP-701-8A below  2-CHANNELS OF 100W
	<b>DT.SL-24150D024</b>	235 X 120 X 56MM	IP67	150w	65A	For dimming use with DT.ECP-701-8A below
	<b>DT.LPV-150</b> 	191 X 63 X 37.5MM	IP67	150w	65A	For dimming use with DT.ECP-701-8A below
	<b>DT.SL-24100D024</b>	249 X 66 X 52MM	IP67	100w	60A	For dimming use with DT.ECP-701-8A below
	<b>DT.LPV-100</b> 	190 X 52 X 37.5MM	IP67	100w	75A	For dimming use with DT.ECP-701-8A below
	<b>DT.SL-VB-240-60P</b>	199 X 66 X 52MM	IP67	60w	55A	For dimming use with DT.ECP-701-8A below
	<b>DT.LPV-60</b> 	162 X 42.5 X 32MM	IP67	60w	60A	For dimming use with DT.ECP-701-8A below
	<b>DT.SL-VB-240-30M</b>	222x 29 x 20	IP67	30w	40A	For dimming use with DT.ECP-701-8A below
	<b>DT.LPV-35</b> 	148 X 40 X 30MM	IP67	30w	55A	For dimming use with DT.ECP-701-8A below
	<b>DT.SL-VA-240-15U</b>	222x 29 x 20MM	IP67	20w	35A	For dimming use with DT.ECP-701-8A below
	<b>DT.ECP-701-8A</b>	82 x 33 x 20mm	IP20	200W MAX 0-10V DIMMING INTERFACE		DIMS DOWN <10% FROM ZERO
	<b>DT.ECP-701-12A</b>	175 x 44 x 33	IP20	200W MAX 0-10V DIMMING INTERFACE		DIMS DOWN <10% FROM ZERO

## DRIVER OPTIONS (continued)





**DT.ECP-701-8A-DALI**  
158x 50.5x 34  
**(DUAL OPERATION)**

IP20

200W MAX DALI DIMMING INTERFACE  
200W MAX DMX DIMMING INTERFACE

## DRIVER OPTIONS TRIAC DIMMING DRIVER - ONE PIECE OPTIONS

Image	Code	dims	IP rating	Power	Inrush (A)	Comment
	DT.ELED-25-24-T	155 x 54 20	20	25w	35A	Works with leading edge TRIAC dimmers
	DT.ELED-50-24T	174x 61x 24mm	20	50W	50A	Works with leading edge TRIAC dimmers
	DT.ELED-80-24T	200x 68.5x 43	66	80W	55A	Works with leading edge TRIAC dimmers

WIRING AS A RING CIRCUIT - OVER 5M

If LED strip is greater than 5m then circuit must be wired as a ring. Drivers can be mounted up to 20m away, provided the above is respected and 1.5mm cable used from the driver to the LED strip. In cases of drivers mounted over 10m from strip a bench test is recommended.

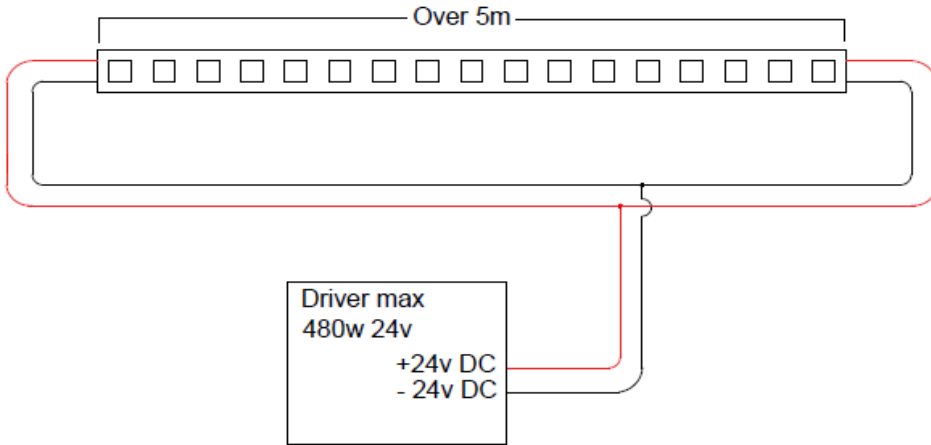

WIRING FOR 0-10V OR DALI DIMMING

This circuit is the standard layout for LED strip of 5m or less. for 5.1m - 10m strip should be fed from both ends (separate diagram available)

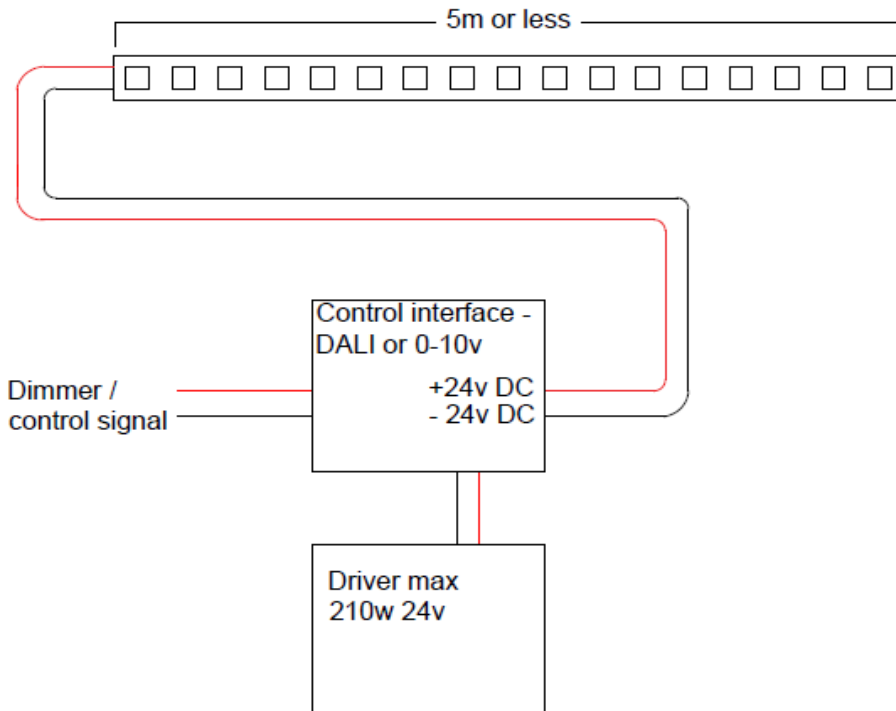

WIRING FOR DMX INTERFACE CONTROL OF RGB

If LED strip is greater than 5m then circuit must be wired as a ring. Drivers can be mounted up to 20m away, provided the above is respected and 1.5mm cable used from the driver to the LED strip. In cases of drivers mounted over 10m from strip a bench test is recommended.

