

Corona-MAX

Product Code DT. 6622-MAX

IP20 Zone 3 **CE** **LED** IEE : A+ EN 60598.

DESCRIPTION / Round LED Recessed dark-light downlight. Adjustable 45deg tilt.

Dimensions (mm)

h100mm (max) x 89mm

WHY USE THIS: Slim discreet anti-glare look, directional. Impressive angle of tilt. Suitable for all general downlight applications especially wall-washing.

Dim-to-warm available

Cut-out (mm)

79

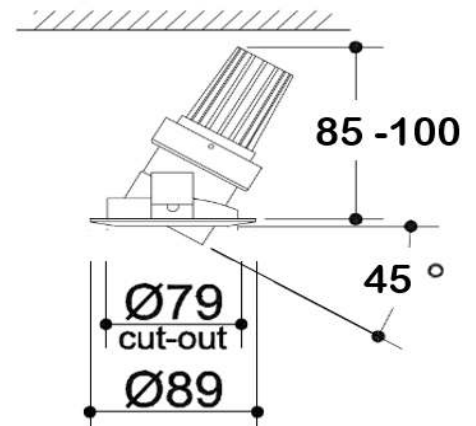

material light fixture	Die Cast Aluminium
colours & finish/ (suffix)	White - 11 or -RAL xxxx
light source & voltage options	a) 9w LED (800 lms) 200 mA 45v b) 11w LED 40 deg (1000 lms) 250 mA 44v c) GU10 7w LED 36 deg (560 lms) 240v DIM TO WARM OPTION AVAILABLE BEAM ANGLES Narrow, medium, wide
colour temperature	2700K / 3000K / 4000K
CRI (colour render)	CRI 90+ or 98 full spectrum
Controls options /(suffix)	Mains dim, 0-10v, DALI Casambi allows individual control of each fixture

technical performance

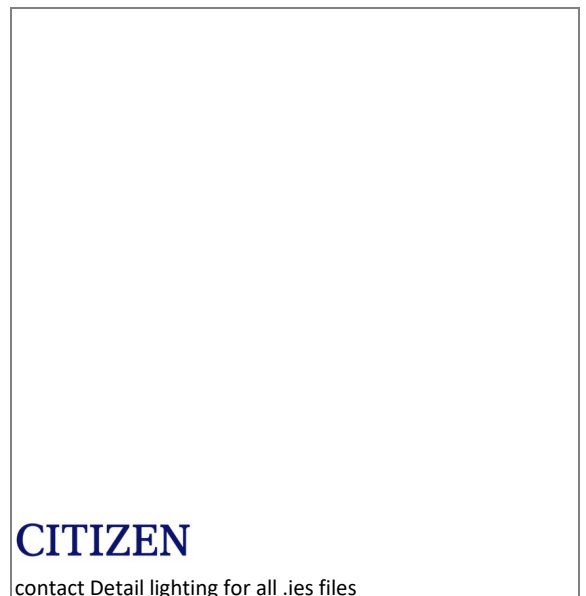

Special Notes

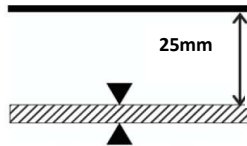

TECH NOTES:

Allow minimum free space of 20mm - 25mm above fixture.
For minimum height see above specification sheet.

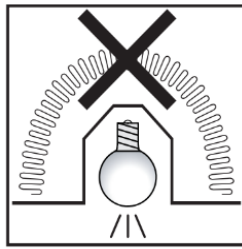

WARNINGS:

Do not cover top of fitting with insulation, as doing so will cause fitting to overheat substantially compromising its life span. Always be aware of any heating or hot water pipes which may cause ambient temperature to exceed 40°C

Turn off power!

1

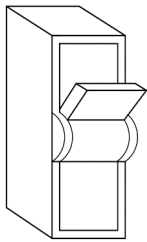

2

CUT DESIRED HOLE, allow free space to achieve 45deg tilt

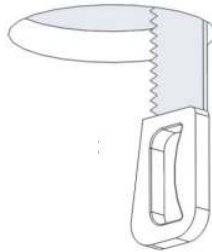

1) Always ensure power is isolated prior to undertaking any electrical work.

2) cut hole in ceiling to size specified for fitting. IF flush fixing frame used, then this is screwed to ceiling now before skimming

3

Make electrical connections as necessary. If light source requires driver pass it through into void at this stage

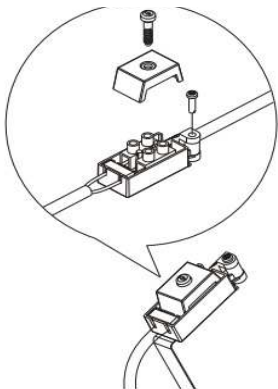

4

UN-CURL SPRINGS BEFORE OFFERING INTO HOLE



3) make electrical connections as necessary. For fittings with remote driver, pass driver through ring into ceiling void at this time.

4) UN-CURL FIXING SPRINGS AND POSITION INTO CEILING HOLE. For wall washing ensure unit is fitted to allow maximum tilt and ensure adequate clearance to any joists or obstructions.