

## CORONA SQUARE

Product Code DT.1318 (add suffix see below)

IP54 Zone 2 **CE** **LED** IEE : A+ EN 60598.

DESCRIPTION / Square LED Recessed dark-light downlight. Adjustable 30deg tilt. IP54

Dimensions (mm)  
h109 x 94 x 94

WHY USE THIS: Classic discreet anti-glare look, Directional. Suitable for all genral downlight applications. Including wet areas.

Cut-out (mm)  
90 x 90

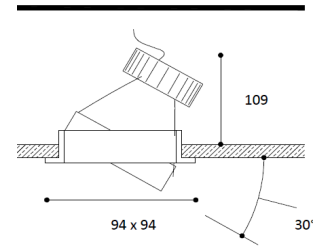

<b>material light fixture</b>	Aluminium body and bezel
<b>colours &amp; finish/ (suffix)</b>	White - 11 or -RAL xxxx
<b>light source &amp; voltage options</b> (PLEASE CONTACT US FOR ALTERNATIVE SOURCES)	a) 15w LED 40deg (1250 lms) 350mA 42.8v b) c) d)
<b>colour temperature /(suffix)</b> <b>CRI (colour render) /(suffix)</b> <b>MacAdam</b>	<b>2700K / 3000K</b> 83 95 <3
<b>Controls options /(suffix)</b>	Phase dimming DALI 0-10v
<b>Optional Accessories</b>	Firehood
<b>AV. Weight (kg)</b>	1
<b>Emergency Available?</b>	Yes
<b>Special Notes</b>	<b>Etched glass as standard</b>

### technical performance

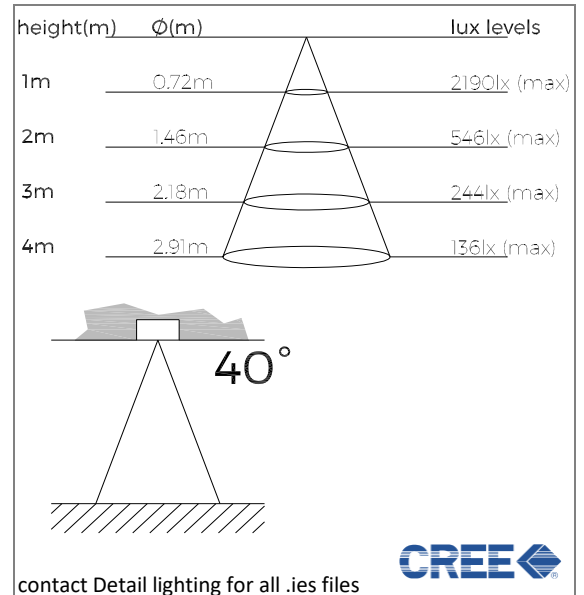

# INSTALLATION

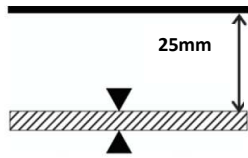

**TECH NOTES:**

Allow minimum free space of 20mm - 25mm above fixture.  
For minimum height see above specification sheet.

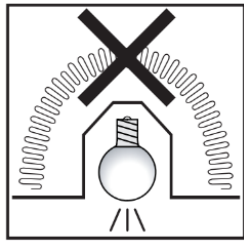

**WARNINGS:**

Do not cover top of fitting with insulation, as doing so will cause fitting to overheat substantially compromising its life span. Always be aware of any heating or hot water pipes which may cause ambient temperature to exceed 40°C

Turn off power!

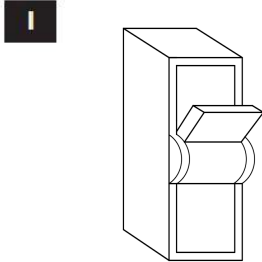

Insert outer ring into ceiling. Compress springs (1) inwards towards ring, then push into cutout.

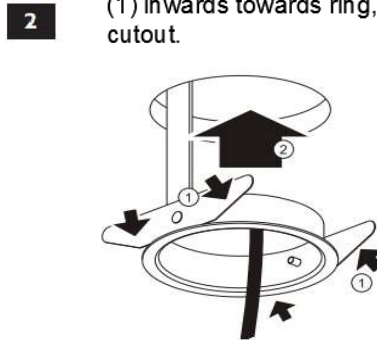

1) Always ensure power is isolated prior to undertaking any electrical work.

Make electrical connections as necessary. If light source requires driver pass it through into void at this stage

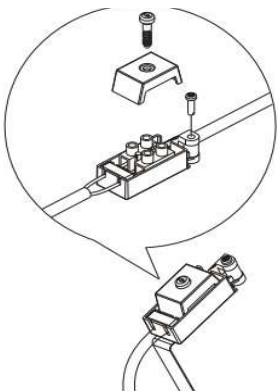

Push fitting up into ring. Fitting will click securely into place.



2) cut hole in ceiling to size specified for fitting. Hold spring clips (1 on drawing) back against installation ring, and push ring up into ceiling. The spring clips will unfold and hold ring into ceiling. For fittings with mousetrap style springs, hold springs straight up, and push fitting into void. the springs will pull the outer ring or fitting into the ceiling.

3) make electrical connections as necessary. For fittings with remote driver, pass driver through ring into ceiling void at this time.

4) push fitting into the outer ring. When installed fitting should be retained with a secure click. For wall washing ensure unit is fitted to allow maximum tilt and ensure adequate clearance to any joists or obstructions.